

SIMPLY YOUR MACHINE.

PIVOT-STEERED TANDEM ROLLERS.



MILLIONS OF KILOMETRES BEAR OUR SIGNATURE.

You build the finest roads so we can all make the quickest progress. And to ensure your rapid progress, we build the best machines. As part of the internationally leading FAYAT Group, we offer machines for all areas of road construction: cold planers, recyclers, asphalt rollers, soil compactors, pavers and, of course, heavy tandem rollers.

For over 60 years, the history of our company has been synonymous with the history of road construction. With our accumulated know-how, we are an innovation driver that sets the pace for an entire industry. BOMAG has developed numerous innovations, such as the uniquely convenient operation of our tandem rollers. They can be individually adapted to the driver's requirements on different levels, such as the seat and operation – turning just a machine into: my machine.

Our latest model sets new standards for the driver not only in terms of comfort, ease of use and safety, but also with regard to price-performance ratio and digitisation: Our TELEMATIC, BOMAP, BOMAP Connect and JOBLINK technologies make a completely digital construction site possible. Comprehensive transparency and planning security included.

We offer you the right solutions for a wide variety of applications. Our global network of experts and partners in over 120 countries are on hand to support you, from the configuration of machines to providing solutions for the most demanding challenges. More than 2,300 BOMAG employees worldwide work with commitment and know-how on something very special: your success.







AWARD-WINNING COMFORT.

ASPHALT COMPACTION IS A MATTER FOR PROFESSIONALS ONLY.

That's why our engineers' goal is to make every new generation of machines even better, more economical and more productive than before.

For one simple reason: to make your work more efficient, convenient and professional.

With technologies such as ECONOMIZER, TanGO⁴ and ASPHALT MANAGER 2, we are setting new standards and demonstrating once again that true innovation must always serve a purpose: because it is the practical innovations and not the technically feasible ones that lead to progress.





That's why we attach so much importance to close contact with you. Because only in this way can we perfectly understand your needs - and find solutions that simplify your wide-ranging tasks and enable a real increase in productivity.

The BW 154 and BW 174 series are the first construction machines ever to bear the seal of quality of the Aktion Gesunder Rücken e.V. (AGR), the German Campaign for Back Health. The AGR quality seal is awarded exclusively to products that have proven their back-friendly design to an independent test commission with experts from a variety of medical fields.

Asphalt rollers
of the BW 154
and BW 174 series

certified &
recommended

AGR
Aktion Gesunder Rücken e.V.

**Forum
Gesunder
Rücken**

BdR
BUNDESVERBAND
DEUTSCHER RÜCKENÄRZTE

FURTHER INFORMATION: WWW.AGR-EV.DE

CONVINCING ON THE JOB SITE AND IN THE OFFICE.

SIMPLY BRIGHT.

- Optional light package with follow-me-home function
- All lights with the latest LED technology
- For best visibility on night construction sites

GREATER ECONOMY.

- BOMAG technology for highest quality standards that pay off
- ECOMODE and ECOSTOP minimise fuel consumption
- Low depreciation, high residual value



OPTIMUM COMPACTION.

- Choice of three vibration systems: double vibration, TanGO oscillation, ASPHALT MANAGER
- Three exciter systems

ALL-ROUND COMFORT.

- Easy access to and from the vehicle
- Practical handles at all service and filling points

PATENTED STEERING.

- Five steering modes for every job site requirement
- Unique automatic steering system
- Ergonomic mini steering wheel

EVENLY SPREAD.

- Patented BOMAG chip spreader (optional)
- Uniform distribution pattern with a precisely defined width
- No overlap, no wastage, no insufficiency
- Spreader can be mounted and removed quickly and simply with the quick attachment system on the side
- Spreader can be laterally adjusted by +/- 20 cm (optional)

PRECISE DOCUMENTATION.

- Highly precise data thanks to ASPHALT MANAGER 2 and E_{VIB} value
- Transparent construction site in real time with BOMAP and BOMAP Connect
- Compaction control for more efficiency with ECONOMIZER





SIMPLY MORE DRIVING COMFORT.

myCOCKPIT

ENHANCED OVERVIEW AND SAFETY.

- Extended windows for excellent overview
- Outside mirrors on the frame at the front: heated (optional) and adjustable from the inside
- Additional mirror for optimum view of the rear drum edge
- Optional supplementary screen on rear of cab displaying camera image, travel and compaction data

EXTRA FEATURES FOR GREATER DRIVING COMFORT.

- Handy USB charging ports
- Ample storage space and holders for lunch box, bottles etc.



PERSONALISED OPERATION.

- Choice of 3 operating options: Touch operation, rotary pushbutton switch or classic switch operation
- High-resolution 10-inch touchscreen display
- Clear, intuitive menu navigation
- Individually configurable and storable driver profiles
- Display individually customisable
- All switches are illuminated and therefore easily recognisable during night operations

INDIVIDUAL COMFORT.

- All functions within easy reach
- Thanks to the release button on the steering wheel, the seat can be moved sideways and rotated without the driver having to take their hand from the wheel
- Air-cushioned premium comfort seat with electronic weight adjustment, active seat ventilation and heating (optional)
- Automatic climate control system (optional)

PRECISE AND COMFORTABLE STEERING.

Exclusive to BOMAG: our practical automatic steering system. The system steers the respective front drum depending on the direction of travel. The rear drum centres itself automatically on start-up. This takes the strain off the driver when reversing – and ensures an excellent result and perfect surfaces.

The generous crabwalk can be activated in two different ways:

- Directly via the travel lever
- By preselection with the rotary switch

On bends, the patented BOMAG steering system reduces the crabwalk automatically when turning. This ensures the roller always travels safely and precisely along the edge, even without manual correction.

The electric steering wheel on the armrest offers maximum ergonomics and precision. The wheel is always in the correct position without obstructing access or views. The operator's arm lies comfortably on the armrest. BOMAG's steering system is unsurpassed in sensitivity.

SIMPLE CHANGEOVER.

Safe operation even when drivers change: the self-explanatory operation is clearly marked, and the switch position is always readily identifiable. Clear symbols and indicators on the display provide information on the machine's operating status.



Directly from the seat and extremely comfortable: perfect view of the drum edge.

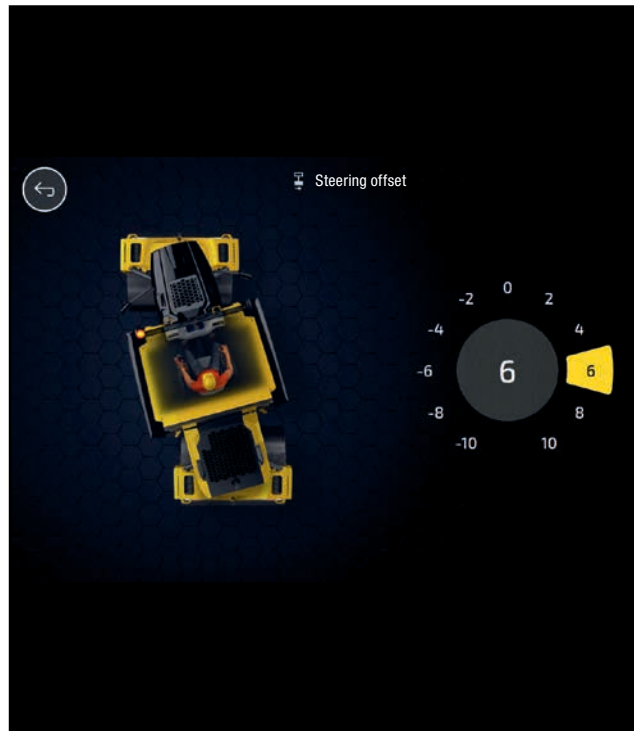

Representation of steering mode in operator's field of view.



Wide range of seat and control adjustments.

BOMAG IS ALWAYS IN THE DRIVER'S SEAT!

The seat can be swivelled by 270° as standard and moved across the entire width of the cab – with a convenient, easy-release swivel adjustment on the armrest. There's no such thing as “back” or “front” any more. Whether chip spreading or compacting edges: the sitting position and view are always optimal. With the optional second screen at the back of the cabin, all important parameters are in view in every direction of travel and from every seating position.

OPERATOR ERGONOMICS AT A WHOLE NEW LEVEL.

The air-cushioned premium comfort seat with electronic weight adjustment, active seat ventilation and heating enables fatigue-free sitting even on long working days.



FULL PLANNING SECURITY: THE DIGITAL CONSTRUCTION SITE.

The new generation of BOMAG tandem rollers is ready for the future. A future in which all machines on the construction site are connected, process data is transmitted in real time, and you can achieve a new level of planning security thanks to 100% transparency.

THE TECHNICAL BASIS: TELEMATIC.

To achieve this comprehensive transparency, BOMAG has combined a whole range of modules into TELEMATIC to provide one integrated solution. It forms the backbone and prerequisite for construction site digitisation.

THE INTERFACE: JOBLINK.

BOMAG machines are equipped with intelligent measuring technology and process sensors. The BOMAG JOBLINK interface collects all process-relevant parameters from measuring systems and the machine and makes them available for further processing, e.g. in BOMAP: E_{VIB} , frequency, amplitude, temperature (on asphalt rollers and pavers), screed width (on pavers), as well as travel speed are just some of the numerous parameters JOBLINK provides to its users. Even machines with ECONOMIZER can provide their compaction information.

THE SMART HELPER: BOMAP.

A connection to BOMAP is automatically initiated when the machine is started. As soon as the wireless connection is established via the JOBLINK plug-and-play Bluetooth adapter, BOMAP takes over the configuration of the machine. All the measuring data appears in the app – without the need for additional equipment. An additional JOBLINK dashboard serves as a visual aid. As a consequence, the relevant measured values can be displayed in the driver's field of vision at any time without losing sight of the lane. The final documentation contains all the measuring data sent to BOMAP via JOBLINK. Regardless of whether it concerns soil compaction or asphalt paving, you now have the ability to meet any future tender requirements, such as Surface Covering Dynamic Compaction Control (SCDCC).

THE UPGRADE. BOMAP CONNECT.

BOMAP Connect links the machines together, for example, to create a complete compaction map of the construction site – across all machines, even from different manufacturers. The result is a transparent construction site. Thanks to this unique link, BOMAG is the only company that can map and document everything from planning to the finished compacted asphalt in real time. For your company, this means: better offers, better work processes, maximum planning capability. Effort and return are optimally balanced.

LEADING DIGITAL SOLUTIONS FOR YOUR CONSTRUCTION SITE.

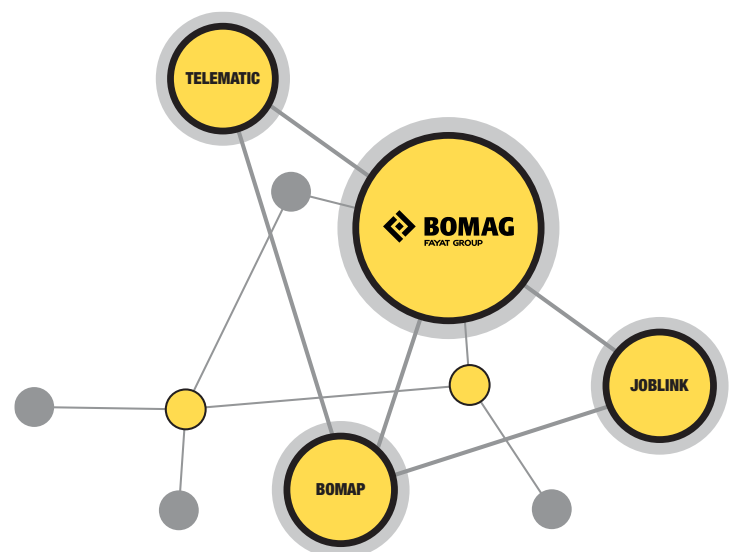



BOMAG MACHINES.
YOUR GUARANTEE
FOR SUCCESS.



JOBLINK.
THE OPEN INTERFACE.

360° DIGITAL



TELEMATIC.
THE EFFICIENT
FLEET MANAGER.



BOMAP.
YOUR SMART HELPER ON
THE CONSTRUCTION SITE.



PROFESSIONAL WORK IS MEASURABLE.

When has full compaction been achieved? Only an operator who knows the degree of compaction can make the right decision. Because nowadays there is no time for unnecessary passes. BOMAG is a pioneer in compaction measuring technology, which today helps many machines achieve optimum compaction results while saving you time and money. Minimum passes with maximum compaction results.

CLEAR ORIENTATION.

In machines with vibration or TanGO⁴, ECONOMIZER (optional) navigates you to the best result. Just keep rolling until the light strip stops getting bigger. Operation is very simple because no activation or calibration is required. A warning light indicates imminent over-compaction in good time.

IT COULDN'T BE MORE PRECISE.

In machines with ASPHALT MANAGER 2, the E_{VIB} value provides even more precise data. E_{VIB} correlates directly with the stiffness of the asphalt and is indicated in MN/m². Only E_{VIB} offers an absolute measurement instead of a relative one: By comparing the E_{VIB} and density measurements, operators can carry out compaction to target values.

ALL DATA, ONE INTERFACE.

A detailed overview of the machines and work processes enables you to work more efficiently. In addition, the complete documentation of all work on the construction site is also becoming increasingly important. We make both

easier for you – with JOBLINK. BOMAG is the only manufacturer to offer you an open interface enabling you to network even mixed fleets without any problems. JOBLINK makes all relevant data collected by our machines available for further processing – e.g. in BOMAP and BOMAP Connect.

A CLEAR OVERVIEW.

With the BOMAP app, asphalt compaction finally becomes transparent, and Surface Covering Dynamic Compaction Control (SCDCC) becomes very simple. The roller driver can display the compaction progress on their smartphone or tablet. The app's user interface is intuitively designed and immediately understandable, even without training.

INTO THE DEPTHS INTUITIVELY.

The BOMAP app draws a live compaction map of the construction site and displays the passes in real time. An easy-to-read and customisable colour scale visualises the compaction progress. The driver sees immediately what needs to be done and where. The number of passes is recorded and can be exported later as a PDF file.



See compaction with new eyes: the ECONOMIZER.



ASPHALT MANAGER 2: everything at a glance.

SAVES TIME AND MONEY.

By using BOMAP, the number of unnecessary passes can be reduced to a minimum. It significantly reduces working time and allows fuel savings of up to 40% while at the same time protecting the machine and the environment. BOMAP improves the results and quality on site and throughout the compaction process.

EVEN GREATER PRECISION.

The BOMAP app uses the mobile device's internal GPS to determine the position. Using our wireless GPS antenna, the map display and documentation of the compaction process can be shown in even more detail: an accuracy of 20 cm is possible. For even greater precision, the antenna can be additionally equipped with a correction service – then a resolution of < 5 cm is achieved.

VISUALISATION IN REAL TIME.

The cloud-based system BOMAP Connect allows machines on the construction site to be networked with each other. The compaction progress of all machines is then continuously visible to every roller driver, clearly visualised and reliably documented. At no point do the drivers make a pass too few or too many.



BOMAG technologies and assistance systems bring transparency to compaction results.

SIMPLY IN THE CLOUD.

The data from all networked rollers is shared via a cloud platform and then displayed directly as a colour map. Coloured areas show the current compaction result achieved by the entire machine fleet. With the quickly comprehensible display of the complex compaction process, every driver can immediately see their current position, which areas have already been compacted and to which degree.

REMOTE CONTROL FOR MULTIPLE JOB SITES.

BOMAP Connect also meets the requirements for location-independent remote access via the Internet. The site manager can also monitor all ongoing projects while on the road and, if necessary, take corrective action. With the help of 3D data and current information from online map services, the important construction site parameters can be determined, and construction processes can be planned in detail.

OPTIMISING, DOCUMENTING, ARCHIVING.

The completed project assignment is then sent to the tablets of the roller drivers, supervisors and site manager at the touch of a button. Changes to the construction or compaction process or fine adjustments to a project plan can also be transmitted to all participants in real time. Once a project has been completed and evaluated, it can be archived just as conveniently at the push of a button.



With BOMAP, you get the full digital compaction record and save working time, fuel, wear and CO₂.

THE CHOICE IS YOURS.

Different construction sites pose different challenges. But on every construction site, one thing is needed above all: the right technology. That's why at BOMAG, you can always choose the technology that best suits your operation and applications. From a single source.



THE CONVENTIONAL CHOICE: DOUBLE VIBRATION.

With two individually switchable amplitudes per drum, this technology covers a wide range of applications. The equipment options are limitless – in first-class BOMAG quality, of course.

FOR SENSITIVE WORK: TANGO.

TanGO⁴ oscillation by BOMAG is used wherever sensitive compaction is required. Highly wear-resistant drums and a warranty of 6,000 operating hours ensure you are always on the safe side. Exclusively from BOMAG: TanGO⁴ with split drums. TanGO requires considerably less drive power than conventional oscillation systems. An extensive field test confirmed: TanGO consumes on average 1.1 l/h less fuel than other oscillation rollers.

FOR THE HIGHEST VERSATILITY:

ASPHALT MANAGER 2.

Also exclusive to BOMAG: just enter the layer thickness, and off you go. Everything is now controlled by ASPHALT MANAGER 2: the subsoil, degree of compaction, temperature, and regulation of the direction of compaction. The driver can now relax and focus on the rolling pattern and the other operators in the team.

HIGHEST QUALITY.

Whoever talks about quality must also be able to guarantee it – as we do: the TanGO and ASPHALT MANAGER 2 drums are manufactured from highly wear-resistant, fine-grained steel. That's why BOMAG guarantees a service life of at least 6,000 hours. No compromises.



Which manufacturer can offer a choice of three exciter systems? BOMAG can. Because BOMAG knows what specialist contractors need.



THE TECHNOLOGY FOR SENSITIVE ROLLING. TANGO⁴.

BOMAG oscillation: with a split drum – without belts. Tango⁴ is the best choice for jobs when sensitive compaction is required.



SIMPLY SPECIAL.

BOMAG Tango⁴ oscillation compacts risk-free, e.g. on seams (hot to cold), bridges, and near buildings. And even better, Tango⁴ is extremely simple to use: it comes with only one amplitude, which is optimised for all applications. The drum cannot bounce because Tango⁴ always works tangentially to the surface.

ALWAYS GENTLE.

This has two important advantages: on the one hand, there is no crushing of aggregate; on the other, no bow waves are generated – even at higher working speeds. The Tango⁴ drum is in the rear of the machine, so the front vibratory drum can be used for thicker layers or stiffer mixes.

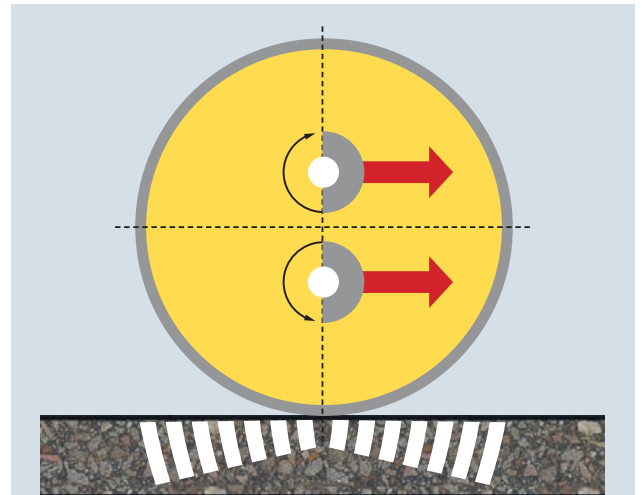

Tango⁴: purely horizontal force distribution.

UNIQUE: OSCILLATION WITH A SPLIT DRUM.

Exclusively available from BOMAG: oscillation with a split drum. Split drums are essential for pivot-steered rollers. This is the only way to utilise their large steering angles without damaging the surface. Tango⁴ BOMAG oscillation means: split drums are standard, making your work easier and more efficient.

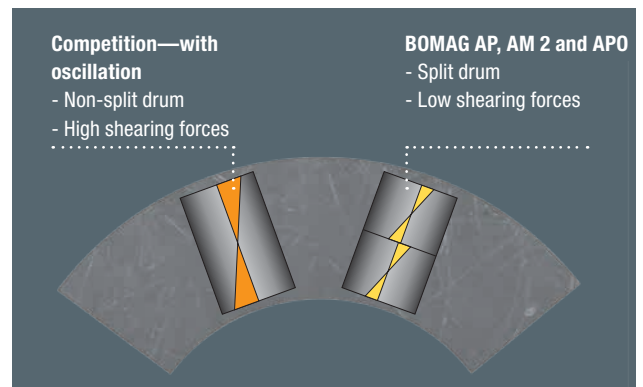

UNIQUE: NO BELTS = NO MAINTENANCE.

Tango⁴ is the only oscillation system to work entirely without belts. Laborious maintenance or downtimes are a thing of the past. This saves valuable time and money.

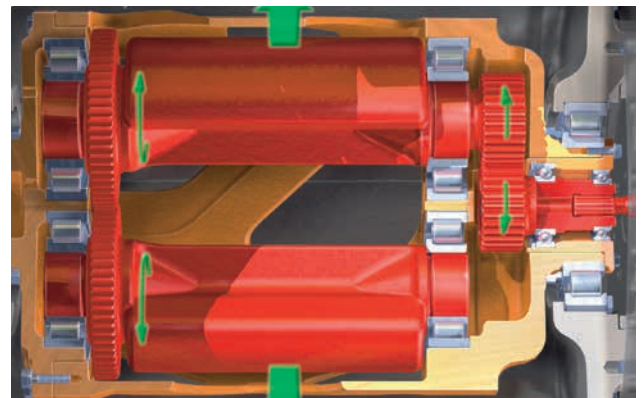

Tango⁴ works entirely without belts.

ASPHALT MANAGER 2: INTELLIGENT, FLEXIBLE COMPACTION.

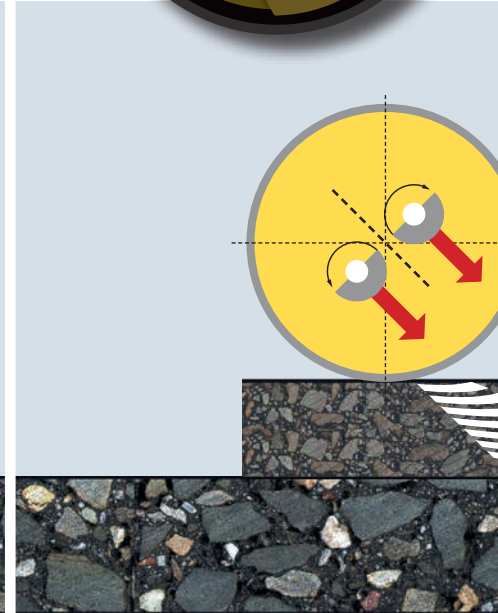
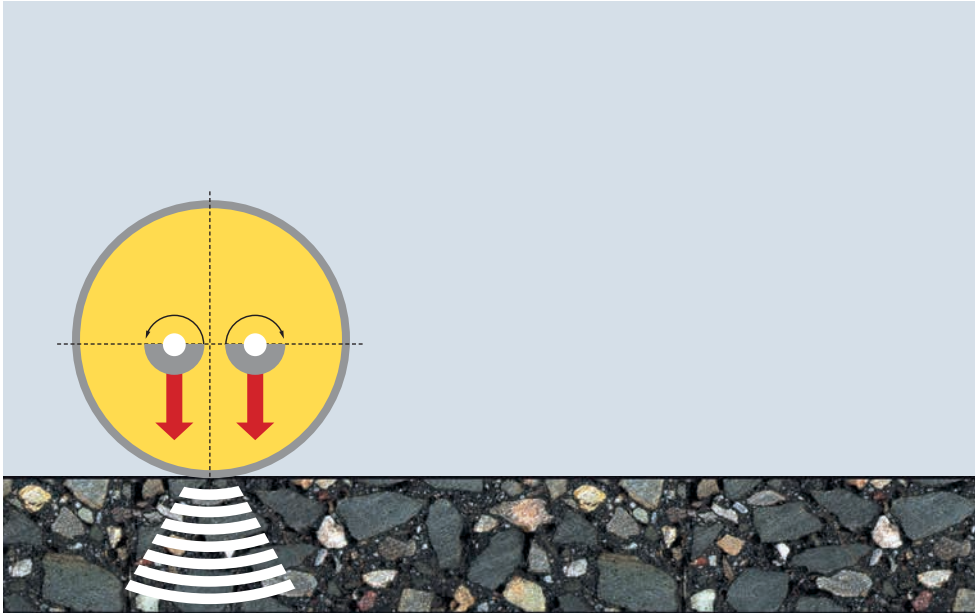

Exclusive to BOMAG: There is no simpler and safer way to compact – because only ASPHALT MANAGER 2 offers infinitely adjustable and automatically controlled amplitude. The electronics measure the material stiffness and adjust the amplitude to the material and pre-selected layer type.

Changing construction sites, changing surfaces, changing convoys. BOMAG has further enhanced ASPHALT MANAGER 2 (AM 2) to make your everyday work even easier. With AM 2, **every driver** can achieve optimal and economical compaction results **at any time** and **on any subsoil**. Because AM 2 **now makes operation even easier**: all the driver has to do is **select the layer type** they are working on – bearing course, binding or top layer. **The AM 2 automatically takes care of the rest.**

No system is as flexible and easy to use as AM 2: the variable amplitude makes both powerful and sensitive work possible. The right force is applied in the right direction in every application: as powerfully as possible and as sensitively as necessary. This achieves the fastest compaction progress, particularly on material that is difficult to compact. In oscillation mode, AM 2 can handle all sensitive applications.

FASTER AND RELIABLE SAVINGS.

With AM 2, you need fewer passes and save time and fuel. Towards the end of compaction or when the asphalt cools down, the amplitude is reduced, which automatically prevents the roller from crushing aggregate.

All parameters such as amplitude, temperature and **now also the stiffness over the last 25 m** as well as the end of compaction are permanently displayed to the driver on the large **10-inch colour screen**.

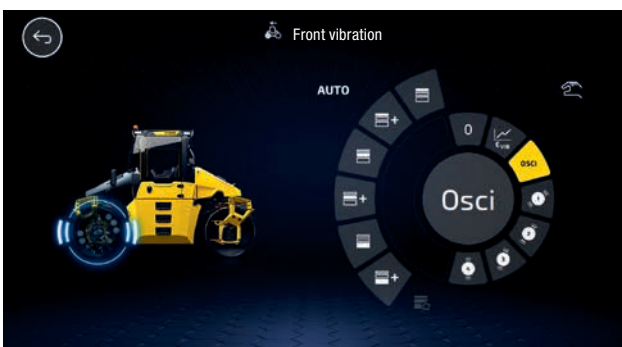

Oscillation mode: selectable at the touch of a button.



Also unique: AM 2 automatically adjusts the vibration direction to the direction of travel. This prevents the formation of bow waves. When stationary, AM 2 automatically switches to horizontal vibration. This effectively prevents drums digging into the mat and, at the same time, achieves extremely short reaction times when rolling recommences.

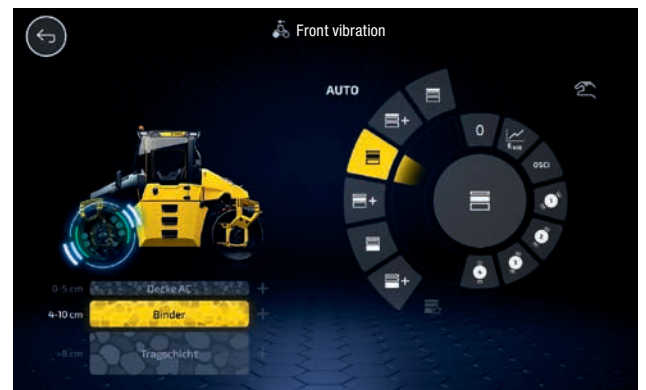

Clear display: all values at a glance, selection of the asphalt layer in the display (fig. top right).

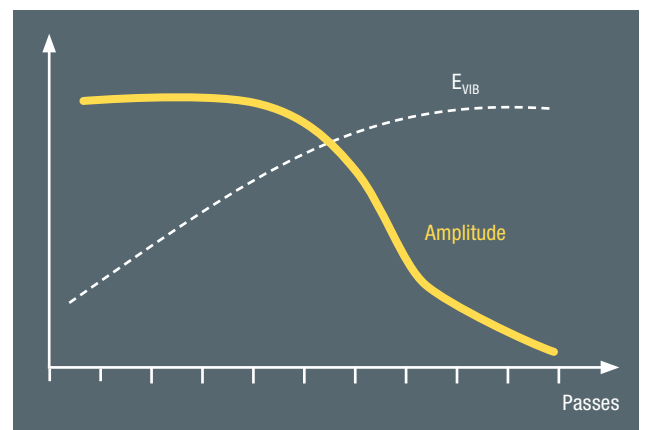

ASPHALT MANAGER 2: The infinitely variable adjustment of the amplitude depending on compaction progress (E_{VIB}) takes place automatically.

BETTER DOWN TO THE SMALLEST DETAIL.

You can only fulfil requirements if you know what they are from the field. This is why BOMAG's AP series was developed in consultation with users – and comes with practical features that make work easier and more efficient. These include the cleverly designed water tanks.

WATER TANKS FOR PROFESSIONALS.

The heavy tandem roller is equipped with two redundant water pumps. The large water tank can be filled from both sides with up to 200 l/min in four minutes. It is located below the cab for a low centre of gravity.

Your advantages:

- Quick, easy filling requiring no pump or climbing
- Low centre of gravity and thus maximum tipping protection
- No machine instability due to sloshing water

To prevent frost damage, any residual water can be flushed out at the touch of a button from the pipes, hoses and nozzles with antifreeze after draining the tank.



TIME-SAVING AND PRACTICAL WHEN FILLING.

The water tanks can be filled from both sides. This avoids the need to rotate the roller to match the supply line's position, saving time and effort. In addition, the water tanks have an easy-to-use hinged cap (rather than a screw cap). The caps are attached to the filler neck to prevent loss.



Antifreeze for spray tubes and nozzles: simply open the screw cap and excess water flows out – the spray tubes and nozzles are then automatically flushed with antifreeze.



Specially developed spray nozzle.

THE EXTRAS MAKE ALL THE DIFFERENCE.

In addition to the well-thought-out and comprehensive standard equipment, BOMAG offers a wide range of additional practical options for your rollers. They make work even more comfortable, and increase on-site safety.



Follow-me-home: machines equipped with the optionally available light package also have the so-called "follow-me-home" function. This means that the two head lights on the cab side at the front remain active for a time after the machine has been switched off, thus lighting the driver's path across the construction site.

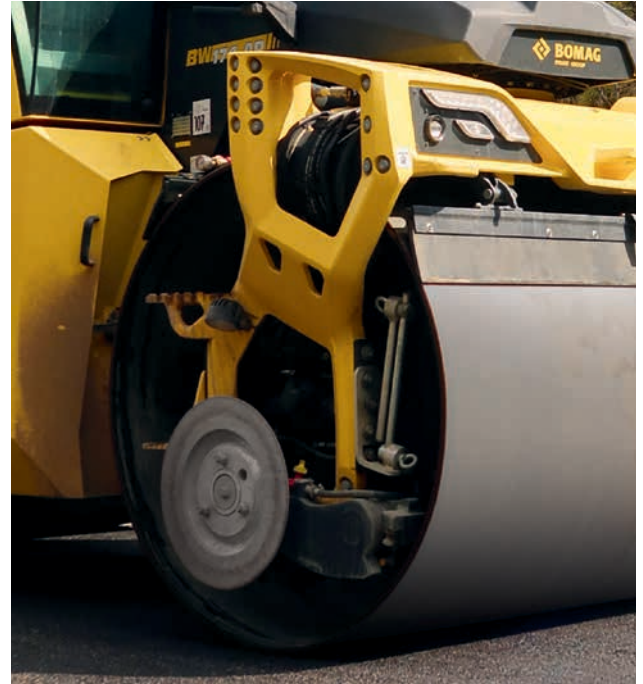

An optional edge cutter with various cutting and compression tools is available for a clean finish on the asphalt edges.

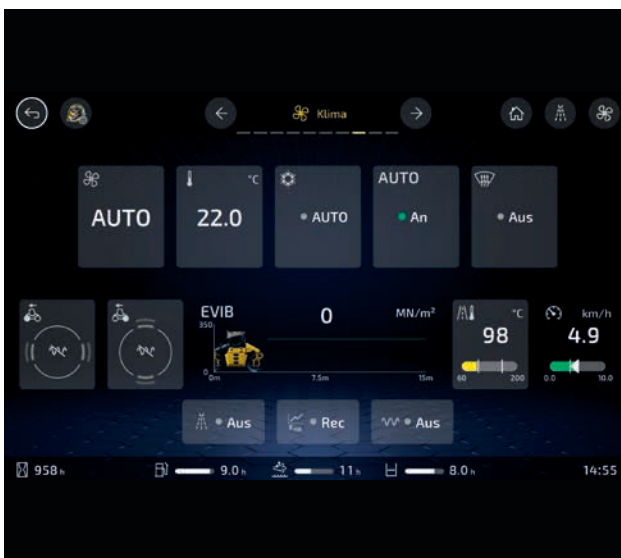

The optional automatic climate control system ensures a constant cabin temperature. The operator simply sets the desired temperature and can then focus on other things.



When compacting with combination rollers, the optional thermal aprons prevent the rubber wheels from cooling down.

ALWAYS THE RIGHT CHOICE: BOMAG ORIGINAL PARTS AND SERVICE.

You deliberately opted for a BOMAG when deciding on your machine. To ensure the long-term performance of your equipment, you can also rely on the tried and trusted quality of BOMAG's services and genuine parts.

ALWAYS IN THE PICTURE: BOMAG TELEMATIC.

With BOMAG TELEMATIC, your machine is always just a mouse click away. You can retrieve locations and operating data at any time to manage your fleet efficiently. Automatic reports provide full transparency on consumption, idle times and optimisation potential.

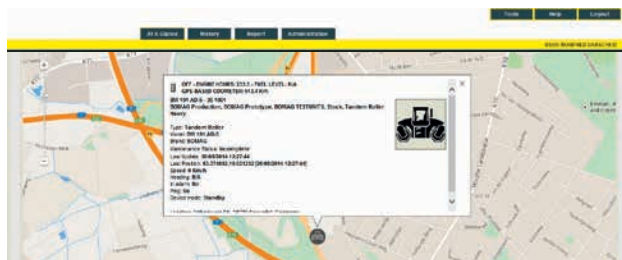

The entire service planning and history is mapped in real time by BOMAG TELEMATIC. If required, the machine reports by email. This avoids downtime. BOMAG TELEMATIC also delivers data to your existing IT technology and consolidates data from different sources. You no longer have to log in to different systems. BOMAG TELEMATIC is the solution for your entire fleet.



PROVEN BOMAG RELIABILITY.

When you purchase a BOMAG machine, professional service and high availability of genuine parts come as standard. With 12 foreign subsidiaries and more than 500 dealers in over 120 countries, we are reliably at your service throughout the world. No matter where your machine is in use, we won't let you down!

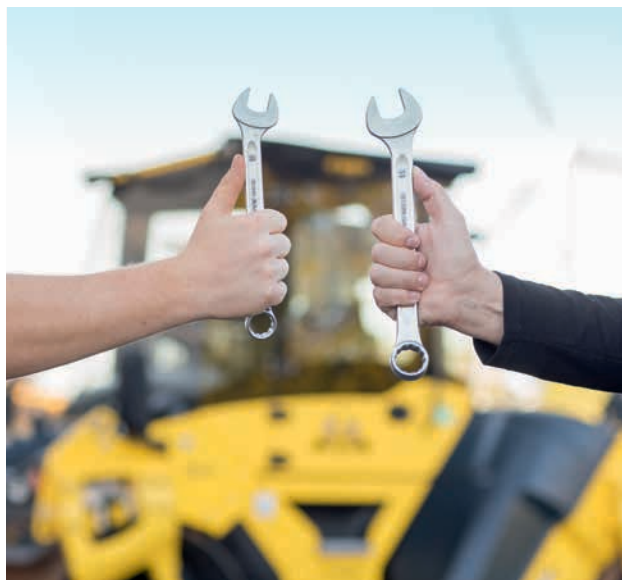

GREATEST VARIETY FOR YOUR ROLLER.

You rightly expect a roller that meets your requirements. That's why BOMAG rollers are as individual as your tasks. We supply a wide range of options including special paintwork, seat heating, bio-oil, and a radio among others: BOMAG makes it possible. We also cater for individual specifications.



BS 150 and BS 180 precision spreaders are suitable for all conventional chippings, including double-crushed chips 2/5 and 1/3 particle size as well as crushed sand particle size 0/2.

PRECISION SPREADER FOR SKID-RESISTANT SURFACES.

The precision spreader optimises the initial skid resistance of asphalt surfaces. The patented vibrating screed technology guarantees a uniform distribution pattern at a defined spread rate. A slider is used to vary the spread width. This prevents material loss at the edges, track overlaps and over-spreading. The vibrating screed even reliably applies damp or bituminised chippings.

Adjusting the camber varies the spread rate and makes it easy to load the roller while providing more transport

space on the trucks. If necessary, the spreader can also be quickly dismantled – by simply inserting the pallet fork into the mount and releasing the quick coupling.

With the optional hydraulic 20 cm side shift, the spreader can also be extended conveniently and safely to the side edges.

Features of BOMAG precision spreader:	BW 154		BW 174	
	BS 150		BS 180	
	Standard	Slidable	Standard	Slidable
Empty weight (spreader with carrier frame)	560 kg	600 kg	640 kg	700 kg
Hopper capacity (max.)	550 l		900 l	
Filling height	1.43 m		1.50 m	
Spreading width	max. 1.50m		max. 1.80m	
Slidable spreader	–	+/- 20 cm	–	+/- 20 cm

MODEL OVERVIEW.



BW 154 AP-5



BW 174 AP-5

Model types	Working width [mm]
BW 154 AP-5	1,500
BW 154 AP-5 AM	1,500
BW 154 APO-5	1,500
BW 154 ACP-5	1,500
BW 154 ACP-5 AM	1,500
BW 174 AP-5	1,680
BW 174 AP-5 AM	1,680
BW 174 AP-5 AM HYBRID	1,680
BW 174 APO-5	1,680
BW 174 ACP-5	1,680
BW 174 ACP-5 AM	1,680
BW 174 ACP-5 AM HYBRID	1,680



BW 174 ACP-5 AM



BW 174 AP-5 AM HYBRID

Approx. operating weight [t]	Compaction system	Combination roller
7.1	Vibration	
7.3	ASPHALT MANAGER 2	
7.9	TanGO ⁴	
7.3	Vibration	X
7.5	ASPHALT MANAGER 2	X
9.4	Vibration	
9.7	ASPHALT MANAGER 2	
9.7	ASPHALT MANAGER 2	
9.7	TanGO ⁴	
9.0	Vibration	X
9.3	ASPHALT MANAGER 2	X
9.3	ASPHALT MANAGER 2	X

Technical modifications reserved. Machines may be shown with optional accessories.



PERFECTION DOESN'T HAPPEN BY CHANCE!

Every BOMAG tandem roller embodies our entire expertise. Down to the smallest detail. So you can put all your experience into your work. The result: visible success. Every time.



Head Office:

BOMAG
Hellerwald
56154 Boppard
GERMANY
Tel. +49 6742 100-0
info@bomag.com

**BOMAG Maschinen-
handels-gesellschaft m.b.H.**

Klausenweg 654
2534 Alland
AUSTRIA
Tel. +43 2258 20202
austria@bomag.com

BOMAG MARINI EQUIPAMENTOS LTDA.

Avenida Clemente Cifali, 530
Distrito Industrial Ritter
Cachoeirinha – RS
BRAZIL
ZIP code 94935-225
Tel. +55 51 2125-6642
brasil@bomag.com

BOMAG (CANADA), INC.

2233 Argentia Road, East Tower
Suites 302
L5N 2X7 Mississauga, ON
CANADA
Tel. +1 800 782 6624
canada@bomag.com

BOMAG (CHANGZHOU)

Construction Machinery Co., Ltd.
No. 66 Bopa Road
Xuejia Town
Xinbei District
Changzhou 213125
CHINA
Tel: +86 519 88585566
china@bomag.com

BOMAG India Pvt Ltd

Unit No. 614, B Wing, 6th Floor
Kanakia Wall Street
Chakala Andheri Kurla Road Andheri East
Mumbai 400 093 Maharashtra
INDIA
Tel.: +91 8657492418
india@bomag.com

BOMAG France S.A.S.

2, Avenue du Général de Gaulle
91170 Viry-Châtillon
FRANCE
Tel. +33 1 69578600
france@bomag.com

BOMAG (GREAT BRITAIN), LTD.

Sheldon Way
Larkfield, Aylesford
Kent ME20 6SE
GREAT BRITAIN
Tel. +44 1622 716611
gb@bomag.com

BOMAG Italia

Via Roma 50
48011 Alfonsine
ITALY
Tel. +39 0544 864235
italy@bomag.com

FAYAT BOMAG Polska Sp. z o.o.

Ul. Szyszkowa 52
02-285 Warszawa
POLAND
Tel. +48 22 482 04 00
poland@bomag.com

FAYAT BOMAG RUS OOO

141400, RF, Moscow region
Khimki, Klayazma block, h. 1-g
RUSSIA
Tel. +7 (495) 287 92 90
russia@bomag.com

BOMAG GmbH

300 Beach Road
The Concourse, #18-06
Singapore 199555
SINGAPORE
Tel. +65 6 294 1277
singapore@bomag.com

BOMAG Americas, Inc.

125 Blue Granite Parkway
Ridgeway SC 29130
U.S.A.
Tel. +1 803 3370700
usa@bomag.com